



PORSCHE BRAKE APPLICATIONS



2018

**FAST ROAD & TRACK DAY BRAKE UPGRADES
RACE DISCS AND PADS**

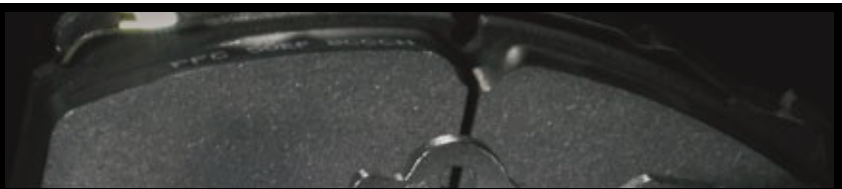

PORSCHE BRAKE APPLICATIONS

PADS

* 7819 use on 350mm PFC discs

MAKE/YEAR	MODEL	APPLICATION	FRONT	REAR
72-83	911	2.2 / 2.3 / 2.7 / 3.2	0045	0031
77-90	911	3.3 SC Turbo, Turbo Sport	0345	0345
79-87	924	2.0	0252	-
78-85	928	4.5	0252	-
80-85	928	S	0395	-
81-85	928	4.7	0253	-
85-95	928	S & S4 & GT	0447	0345
91-95	928	5.4 GTS 32V	0594	0345
85-87	944	2.5 Turbo	0345	0345
87-91	944	2.5 Turbo	0447	0345
88-91	944	2.7 & 3.0 S2	0345	0345
88-91	964	C2 3.6	0345	-
91-94	964	C2 3.6	0345	0345
88-94	964	3.6 C4	0345	0345
91-93	964	3.6 Carrera RS	0447	0345
88-91	964	3.3 Turbo & Turbo S	0447	0345
91-93	964	3.3/3.6 Turbo/Turbo S	0594	0345
91-95	968	3.0 Coupe	0345	0345
91-95	968	3.0 Coupe Sport	0447	0345
93-95	968	3.0 Coupe Turbo S	0594	0345
12-	981	Boxster S	1389	0776
13-	981c	Cayman S steel brakes	1389	0738
15-	981c	Cayman GT4	7721	7727
15-	981c	Cayman GT4 (use with PFC 380mm)	1773	7727
96-05	986	Boxster	0737	0738
99-05	986	Boxster S	0776	0738
06-09	987c	Cayman S	0737	0738
05-12	987	Boxster	0737	0738
05-12	987	Boxster S	0776	0738
05-12	987	Boxster S ceramic brakes	0991	0776
09-12	987c	Cayman	0776	0738
06-12	987c	Cayman S	0776	0738
11-	991	3.4 C steel brakes	1389	1390
13-	991	GT3 / Turbo / Turbo S steel brakes	7721	7727
13-	991	Cup	7968	7969
13-	991	GT3 R / RS (use with PFC 380mm)	1773	7727
93-97	993	3.6 Carrera & C4	0447	0345
95-97	993	3.8 Carrera & C4	0447	0345
95-97	993	3.6 Turbo & Turbo GT2	0594	0447
95-97	993	3.8 Carrera RS & RSR	0594	0447
95-97	993	GT2 & RSR (380 disc)	0594 (25mm)	0447
97-05	996	3.4 C & 3.6	0776	0738
01-	996	C4 S	7818	0776
97-98	996	3.4 C Super-Cup	0594	0776
99-01	996	3.4 C Super-Cup	7818	0776
00-05	996	GT3 R & GT3 RS	0594 (25mm)	7700 (25mm)
99-01	996	GT3 & 996 Turbo	7818	0776
02-	996	Turbo	7818	0776
02-	996	GT3	7819* / 0991	0776
02-	996	GT3 Super-Cup	7819*	0776
02-	996	GT2	7819* / 0991	0776
04-	997	Carrera GT	0991	0776
05-08	997	3.6 C / 3,6 C4	0776	0738
08-	997	3.6 C / 3,6 C4	1389	1299
05-08	997	3.8 C S / 3,8 C4 S	7818	0776
08-	997	3.8 C S / 3,8 C4 S	7818	1299
09-	997	3.8 GTS	7818	0776
05-	997	all models with PCCB	0991	1299
06-	997	GT3,GT3 RS,Turbo,GT2	0991 / 7819*	1299
05-	997	GT3 Cup	7819*	1299
07-	997	GT3 Cup S / Grand Am	7797 (22mm)	7700 (20mm)
07-	997	GT3R / RSR	7797 (29mm)	7700 (25mm)

PORSCHE BRAKE APPLICATIONS

PAD COMPOUNDS

CarbonMetallic®

Compound Groups

13

13 Compound
35 Compound
07 Compound
05 Compound
03 Compound
93 Compound
83 Compound

13 Compound is a new generation of ultimate high bite-high friction. 13 compound has been developed with increased bite, modulation, with superior disc conditioning and release characteristics for exceptional control. Ultra smooth and great for tracks with high grip or high downforce cars. It is the ultimate combination of high bite and infinite control.

Typical Applications; Ideal use for sprint and severe applications, heavy, high speed applications or high downforce cars where high bite at the first 3rd of the stop is desired. 13's wear is on a par with PFC's legendary 01 compound and will operate at higher temperatures if called too as .13 has a very high threshold for fade resistance. Out of all the high bite, high torque pads in the market 13 has shown to have one of the lowest taper wear in a properly designed race caliper.

11

11 Compound
01 Compound
99 Compound
90 Compound

11 Compound is a new generation sprint and medium distance friction providing the ultimate in control, with superior disc conditioning. 11 compound was developed from the 01 compound with improved bite, modulation, and release characteristics. It is ultra smooth and developed to reduce wheel locking at the end of a stop. For many applications, 11 will replace the venerable 01 compound.

Typical Applications; Ideal for use at medium-low grip venues where control and modulation is at a premium. Also in racing applications where ABS systems are used, .11 can be used in a large spectrum of temperature ranges. 11's wear is par with PFC's legendary 01 compound showing virtually zero taper wear when raced in a properly designed race caliper.

08

08 Compound
06 Compound
97 Compound

08 compound has gained immediate favour in Endurance Sportscar and GT racing and also in endurance production car racing due to its performance in applications where smooth initial bite is a must. 08 has a slight friction rise with temperature with excellent release and modulation characteristics. Very low abraded disc wear with a fine grey slate like disc finish, similar to 01.

Despite its considerable performance, 08 wears the longest of all PFC pads and easily matches wear of the other competitors with much higher bite. If temperature isn't an issue, 08 can be replaced with 12 compound. **Typical Applications;** Endurance, GT and endurance production car racing, trackday

12

12 Compound
06 Compound
97 Compound

12 Compound is a new generation endurance friction—excellent bite with 24 hour durability in its DNA and superior disc conditioning. 12 compound was developed from 08 Compound with improved wear, modulation, and release characteristics. It provides the ultimate in low wear. The PFC .12 Compound won in its debut race the 2013 Daytona 24hr overall winner. 12 compounds wear is lower than 08 when high temperatures is not an issue.

Typical Applications; Ideal use for endurance when low wear is at a premium. Also race applications where ABS systems are used. 12's wear is at its optimum when disc temperature paints show 450-500c operating temperatures but will operate at higher temperatures if called to. Virtually zero taper wear when raced in a properly designed race caliper.

More information on pad compounds can be found on the PFC Brakes Europe website - www.pfcbrakes.eu

PAD PROFILES

PAD COMPOUNDS AVAILABLE

PART NUMBERING AS FOLLOWS:

Pad Shape **0008** Compound **.11** Total Thickness **.15** (mm)

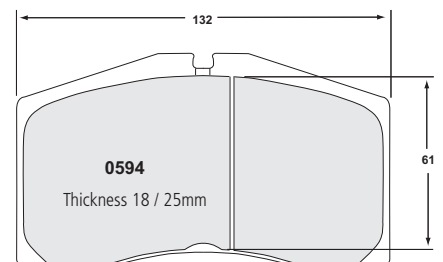
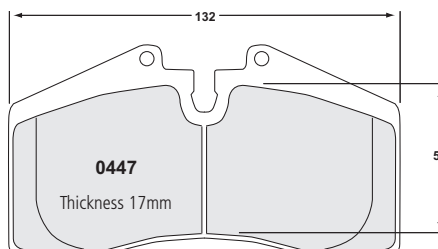
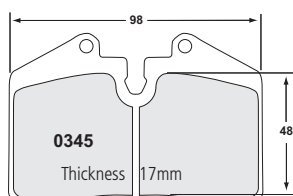
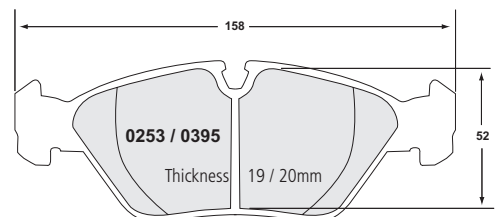
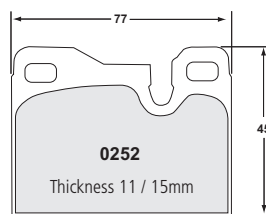
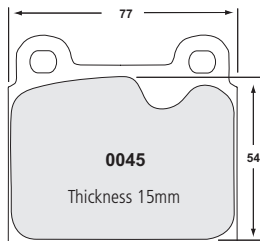
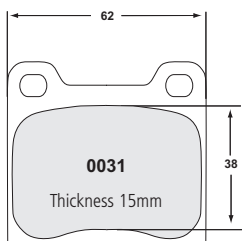



PORSCHE BRAKE APPLICATIONS

PAD PROFILES

PAD COMPOUNDS AVAILABLE

PART NUMBERING AS FOLLOWS:

Pad Shape **0031** Compound **.11** Total Thickness **.15** (mm)

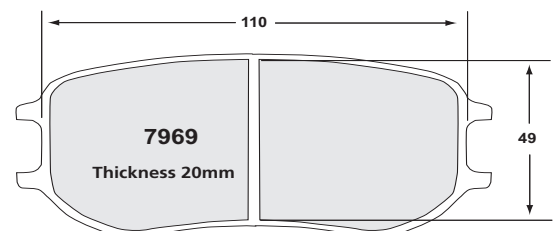
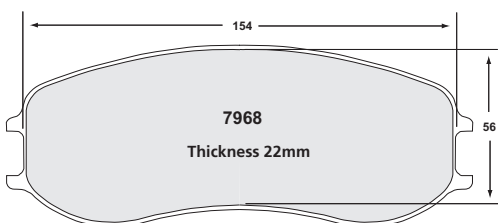
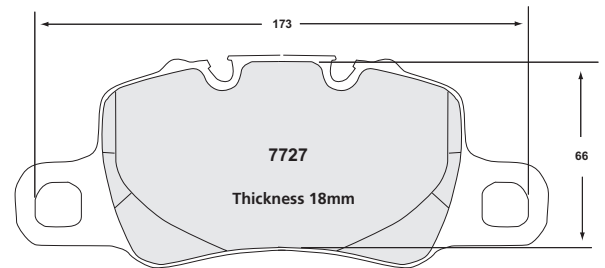
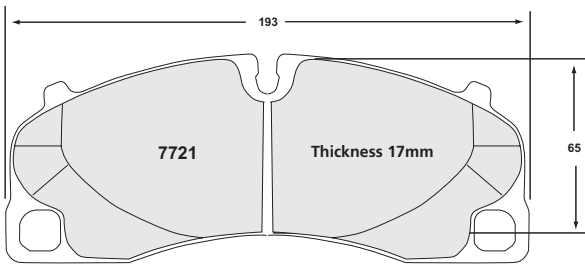
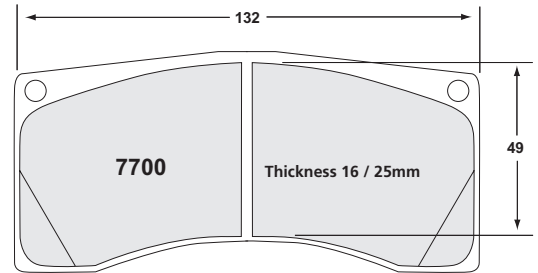
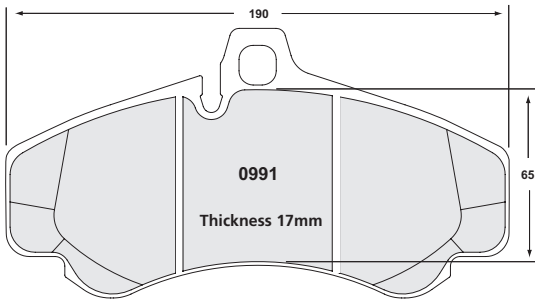
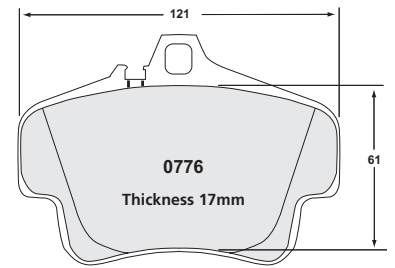
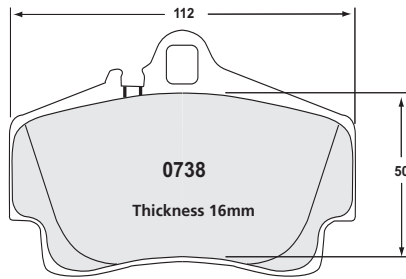
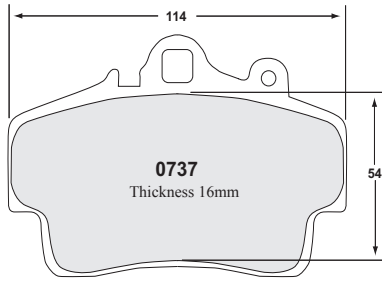



PORSCHE BRAKE APPLICATIONS

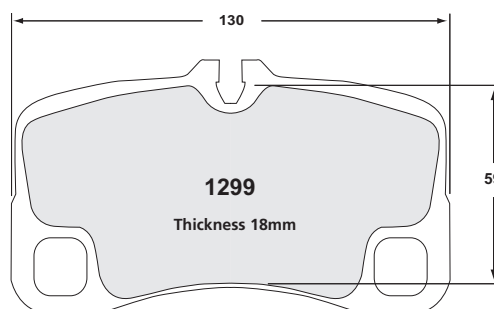
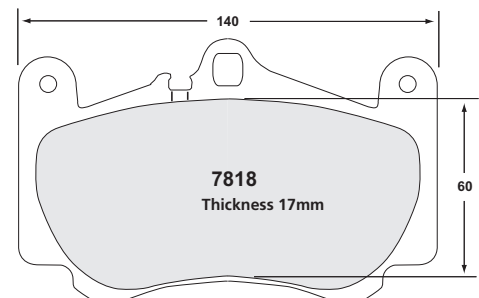
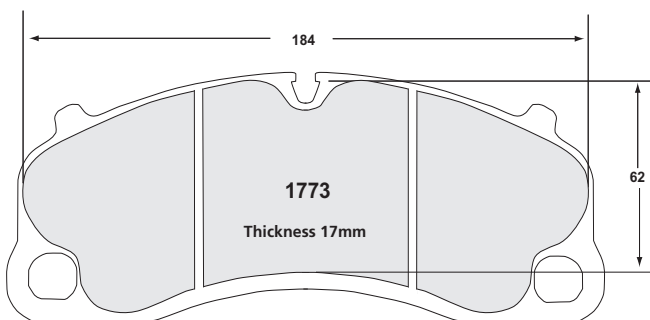
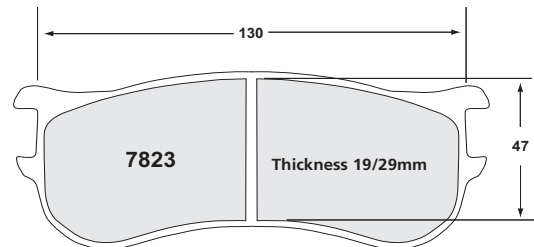
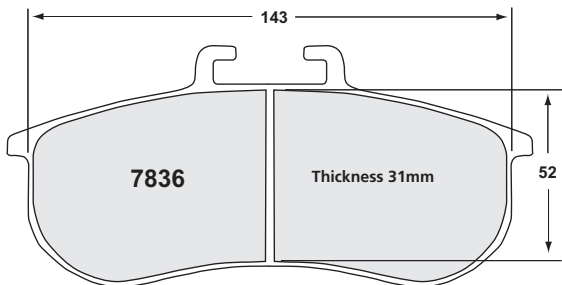
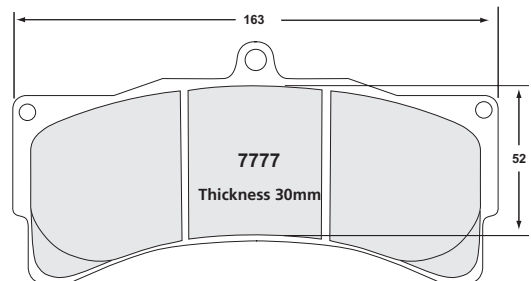
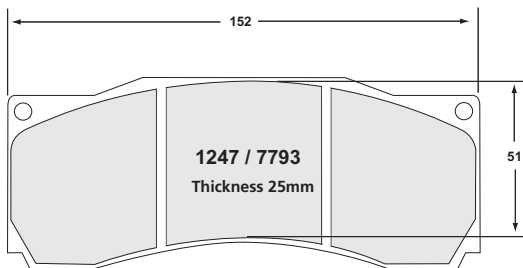
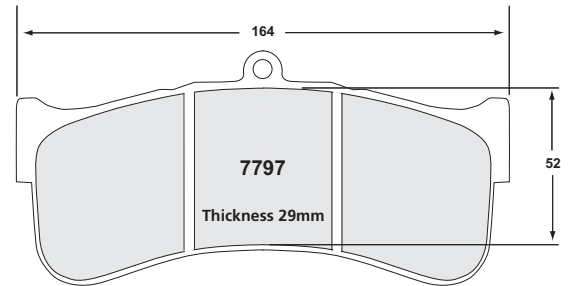
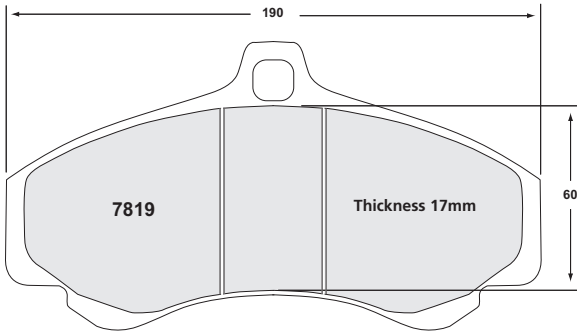

Two-Piece Floating Direct Drive™ Disc Upgrade Application List



MODEL	DISC FRONT/REAR	DISC	FRONT PAD	REAR PAD
986, Boxster S, 96 > 05 V3 two piece floating assembly Replacement disc for 318.067.63/64	Front	318.067.63/64 318.28.0061.451/461	0776	0738
982c Cayman GT4 2015 > V3 two piece floating assembly Replacement disc for 380.070.63/64	Front	380.070.63/64 380.34.0062.451/461	1773*/7721	7727
982c Cayman GT4 2015 > V3 two piece floating assembly Replacement disc for 380.075.63/64	Rear	380.075.63/64	1773*/7721	7727
987, Boxster 3.2 / 3.4 05 > V3 two piece floating assembly Replacement disc for 318.067.63/64	Front	318.067.63/64 318.28.0061.451/461	0776	0738
996, C2 / C4, 97 > 05, V3 two piece floating assembly Replacement disc for 318.067.63/64	Front	318.067.63/64 318.28.0061.451/461	0776	0738
996, GT3 / 2 / RS, 98 > 04, V3 two piece floating assembly Replacement disc for 350.068.63/64	Front	350.068.63/64 350.34.0060.451/461	7819*/ 0991	0776
997, C2 / C4, 04 > 11, V3 two piece floating assembly Replacement disc for 318.067.63/64	Front	318.067.63/64 318.28.0061.451/461	0776	0738
997, GT3 / 2 / RS, 04 > 08, V3 two piece floating assembly) Replacement disc for 350.068.63/64	Front	350.068.63/64 350.34.0060.451/461	7819*/ 0991	0776 / 1299
997, GT3 / RS / Turbo, 05 > 11 V3 two piece floating assembly Replacement disc for 348.076.85/86	Rear	348.076.67/68 348.29.0060.43/44	7819	1299
997, GT3, 2011 > PCCB & Iron, V3 two piece floating assembly (Standard & centre lock wheels) Replacement disc for 379.067.63/64	Front	379.067.63/64 379.34.0066.451/461	0991	1299
997, Turbo, C4, 2011 > PCCB & Iron, V3 two piece floating assembly (Inc road centre lock wheels) Replacement disc for 379.069.63/64	Front	379.069.63/64 379.34.0066.451/461	0991	1299
997, All Gen II cars, 2011 > PCCB & Iron, V2 two piece floating assembly Replacement disc for 348.076.85/86	Rear	348.076.67/68 348.29.0060.43/44	0991	1299
991 GT3 R / RS 2013 > V3 two piece floating assembly Replacement disc for 380.070.63/64	Front	380.070.63/64 380.34.0062.451/461	1773*/7721	7727
991 GT3 R / RS 2013 > V3 two piece floating assembly Replacement disc for 380.075.63/64	Rear	380.075.63/64 380.30.0065.451/461	1773*/7721	7727



All V3 discs are slotted

7819* to be used with PFC 350mm disc
1773* to be used with PFC 380mm disc



Performance Friction Europe

Carbon Metallic House, Wildmere Road, Banbury, Oxon OX16 3LU United Kingdom

Tel: +44(0)1295 221020

Fax: +44(0)1295 279711

uksales@pfcbrakes.com

www.pfcbrakes.eu

PORSCHE BRAKE APPLICATIONS

RACE DISCS - FRONT

MODEL	SPEC	CALIPER	PAD	HAT	DISC	BOBBIN
991 GT3 Cup	Race	na	7968 - 22mm	na	PFC 380.32.0054.45/46	na
981c Cayman GT4	Race	na	7968 - 22mm	na	PFC 380.32.0054.45/46	na
996 GT2	Endurance	PFC ZR27	7836 - 31mm	PFC V2 240.155.385.13	PFC 378.35.0051.45/46	na
	Sprint	PFC ZR27	7836 - 31mm	PFC V2 240.155.385.13	PFC 378.32.0051.45/46	na
996 GT3R		Brembo 4 pot OE Porsche	0594 - 25mm	Brembo / Porsche	PFC 378.32.0060.03/04	Brembo Pin type
		Brembo 4 pot OE Porsche	0594 - 25mm	PFC 237.103.029.01	PFC 378.32.0060.01/02	PFC 900.700.003.01
996 GT3 RS	Endurance	Brembo 6 pot motorsport	7797 - 29mm	Brembo / Porsche	PFC 378.35.0051.03/04	Brembo Pin type
	Endurance	Brembo 6 pot motorsport	7797 - 29mm	PFC 256.103.281.01	PFC 378.35.0051.01/02	PFC 900.700.003.01
	Endurance	AP 6 pot monobloc	7777 - 30mm	AP / Porsche	PFC 378.35.0051.03/04	Ap mtg kit
	Endurance	AP 6 pot monobloc	7777 - 30mm	PFC 256.103.281.01	PFC 378.35.0051.01/02	PFC 900.700.003.01
	Endurance	PFC ZR27	7836 - 31mm	251.157.310.12	PFC 378.35.0051.07/08	PFC 900.700.775.02
	Sprint	Brembo 6 pot motorsport	7797 - 29mm	Brembo / Porsche	PFC 378.32.0051.03/04	Brembo Pin type
	Sprint	Brembo 6 pot motorsport	7797 - 29mm	PFC 256.103.296.01	PFC 378.32.0051.01/02	PFC 900.700.003.01
	Sprint	AP 6 pot	7793 - 25mm	AP / Porsche	PFC 378.32.0051.03/04	Ap mtg kit
	Sprint	AP 6 pot	7793 - 25mm	PFC 256.103.296.01	PFC 378.32.0051.01/02	PFC 900.700.003.01
	Sprint	PFC ZR27	7836 - 31mm	251.157.310.12	PFC 378.25.0051.07/08	PFC 900.700.675.02
	996 GT3 RS	Cup	Brembo 6 pot OE Porsche	7819 - 17mm	Brembo / Porsche	PFC 378.32.0060.03/04
				PFC 237.103.029.01	PFC 378.32.0060.01/02	PFC 900.700.003.01
997 GT3	Cup - 2008 -	Brembo 6 pot OE Porsche	7819 - 17mm	Brembo / Porsche	PFC 378.32.0060.03/04	Brembo Pin type
				PFC 237.103.029.01	PFC 378.32.0060.01/02	PFC 900.700.003.01
997 GT3	Cup & S 2008 -	Brembo 6 pot OE Porsche	7819 - 17mm	Brembo / Porsche	PFC 378.32.0060.03/04	Brembo Pin type
				PFC 237.103.029.01	PFC 378.32.0060.01/02	PFC 900.700.003.01
997 GT3	Cup Australia	Brembo 6 pot OE Porsche	7819 - 17mm	PFC V2 219.157.272.13	PFC 378.34.0060.45/46	na
997 GT3 RSR	Endurance	PFC ZR27	7836 - 31mm	PFC V2 240.155.385.13	PFC 378.35.0051.45/46	na
	Sprint	PFC ZR27	7836 - 31mm	PFC V2 240.155.385.13	PFC 378.32.0051.45/46	na
997 GT3	Cup	Brembo 6 pot OE Caliper	7819 - 17mm	V3 Assembly Replacement disc	PFC 378.066.61/62 PFC 378.32.0060.651/661	na na

PFC V2 & V3 DIRECT DRIVE™ SYSTEM

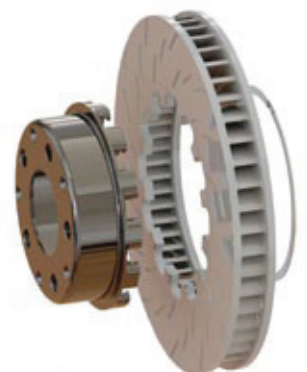
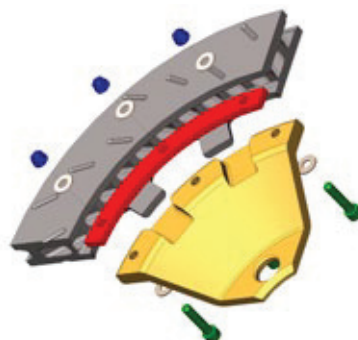

PORSCHE BRAKE APPLICATIONS

RACE DISCS - REAR

CALIPER	PAD	HAT	DISC	BOBBIN
na	7969 - 20mm	na	PFC 380.30.0047.45/46	na
na	7969 - 20mm	na	PFC 380.30.0047.45/46	na
PFC ZR22	7823 - 29mm	PFC V2 223.155.430.13	PFC V2 355.32.0047.45/46	na
PFC ZR22	7823 - 29mm	PFC V2 223.155.430.13	PFC V2 355.30.0047.45/46	na
Brembo 4 pot motorsport	7700 - 25mm	Brembo / Porsche PFC 237.103.030.01	PFC 355.32.0048.03/04 PFC 355.32.0048.05/06	Brembo Pin type PFC 900.700.003.01
Brembo 4 pot motorsport	7700 - 25mm	Brembo / Porsche PFC 237.103.030.01	PFC 355.32.0048.03/04 PFC 355.32.0048.05/06	Brembo Pin type PFC 900.700.003.01
Brembo 4 pot motorsport	7700 - 25mm	Brembo / Porsche PFC 237.103.030.01	PFC 355.32.0048.03/04 PFC 355.32.0048.05/06	Brembo Pin type PFC 900.700.003.01
Brembo 4 pot OE Porsche	0776 - 17mm	na	Brembo 350mm 1 peice	na
Brembo 4 pot OE Porsche	1299 - 18mm	na	Brembo 350mm 1 peice	na
Brembo 4 pot OE Porsche	1299 - 18mm	na	Brembo 350mm 2 peice	T Bobbin
Brembo 4 pot OE Porsche	1299 - 18mm	PFC V2 203.157.395.13	PFC 348.29.0060.45/46	na
PFC ZR22	7823 - 29mm	PFC V2 223.155.423.13	PFC 355.32.0047.45/46	na
PFC ZR22	7823 - 29mm	PFC V2 223.155.423.13	PFC 355.30.0047.45/46	na
Brembo 4 pot OE Porsche	1299 - 18mm	V3Assembly Replacement disc	PFC 348.075.61/62 PFC 348.29.0060.651/661	na na

PFC
BRAKES



PFC V3

Performance Friction Europe

Tel: +44(0)1295 221020
uksales@pfcbrakes.com

www.pfcbrakes.eu



@pfcbrakeseurope